

BUNGER STEEL

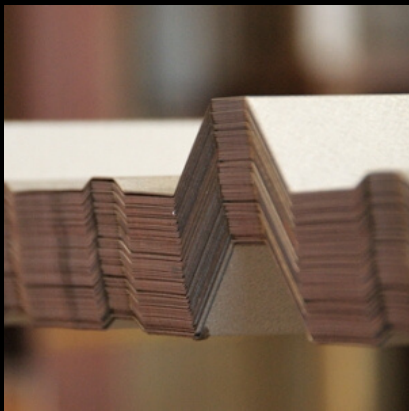

COMPONENTS CATALOG

THE BENEFITS OF METAL ROOFING

EVERYTHING YOU WANT YOUR PROJECT TO BE.

BEAUTY.

With 15 different colors and six different panel profiles your roof will look fresh and vibrant for decades.

DURABILITY.

Metal roofs last longer than composition roofs or wooden shingles.

LONGEVITY.

Bunger Steel offers limited paint warranties for up to 35 years.

SAVINGS.

Insurance companies offer discounts of up to 35% for homes with metal roofs.

WEATHER RESISTENT.

Bunger Steel roofs offer superior protection from wind, hail and fire.

ENERGY EFFICIENT.

Bunger Steel roofs have high-tech coatings and can help utility bills.



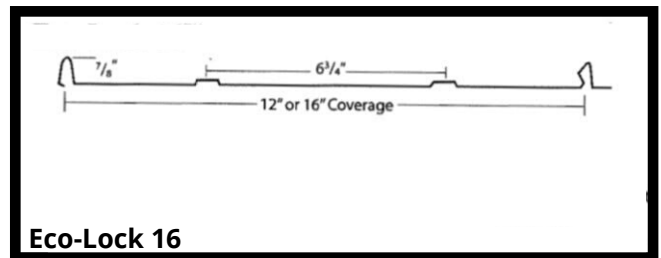
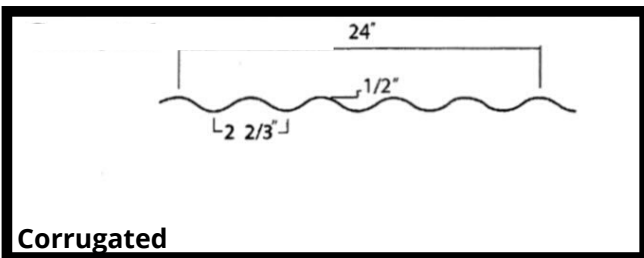
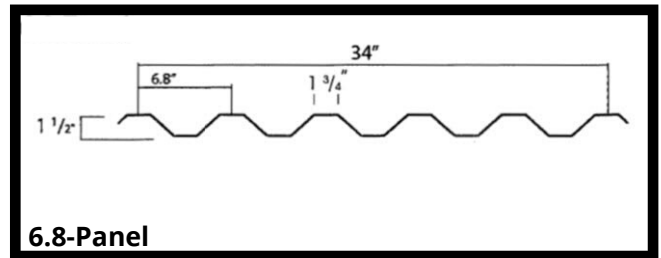
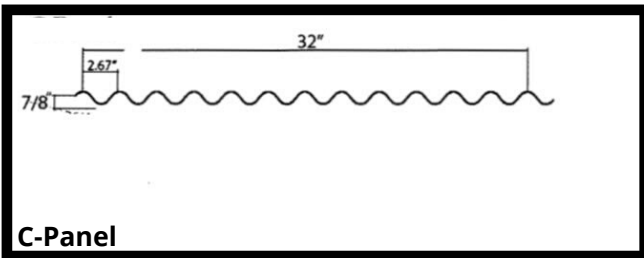
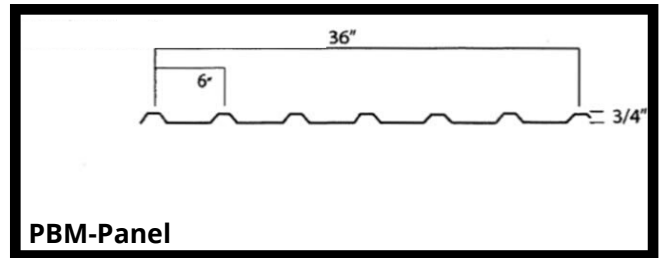
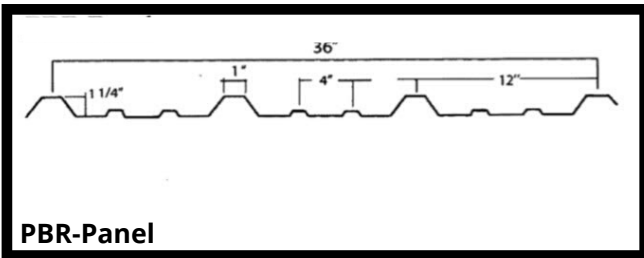

MULTIPLE GAUGES AVAILABLE

**BUNGER
STEEL
.COM**

**35 YEAR LIMITED PAINT
WARRANTY**

**20 YEAR LIMITED WARRANTY
ON GALVALUME**

CUSTOM LENGTHS,
FIRE RESISTANT, EASY APPLICATION, HAIL
RESISTANT, DURABLE AND ENERGY EFFICIENT.

1-800-3BUNGER

Rake Trim

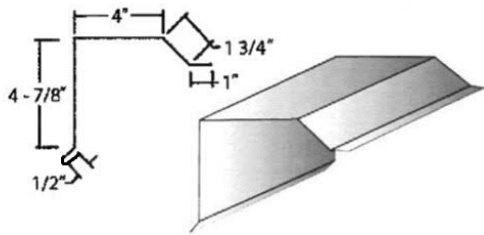

Eave Trim

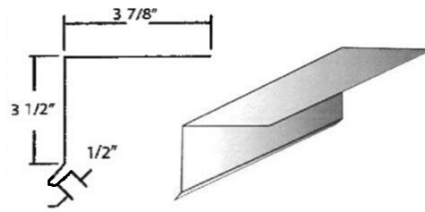

Ridge/Hip Flash

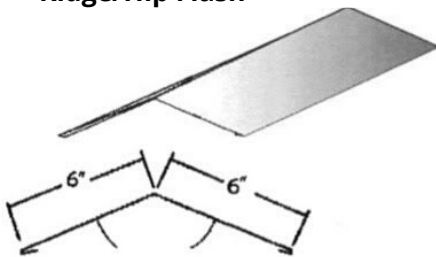

Flat Ridge Cap

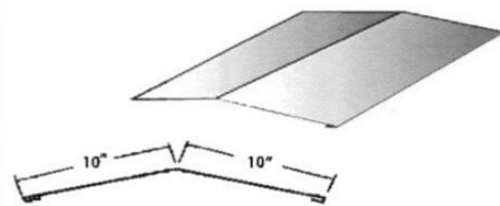

Parapet Rake

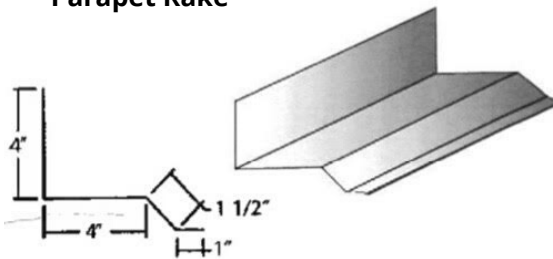

High Side Transition

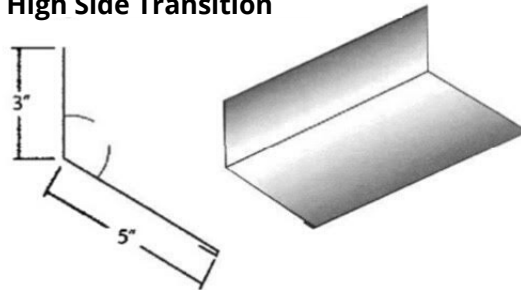

Fascia Wrap

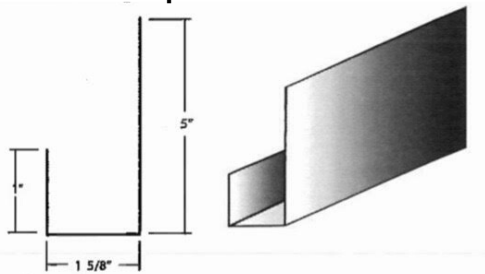

Inside/Outside Closure (PBR Panel)

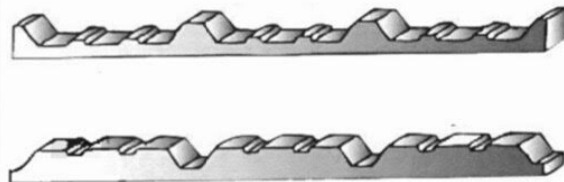

*AVAILABLE FOR ALL BSI PANELS

Standard Valley

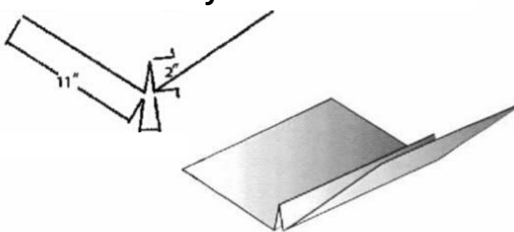

Extended Valley

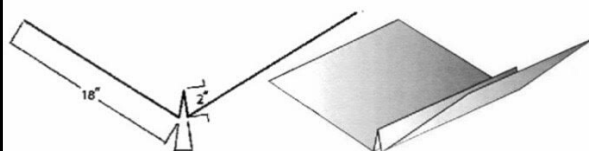

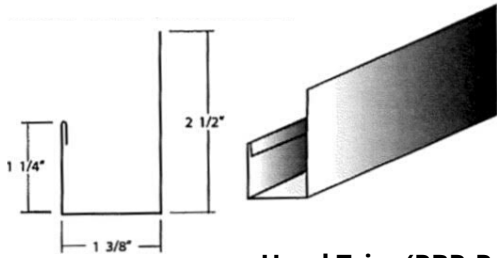

Head Trim (PBR-Panel)

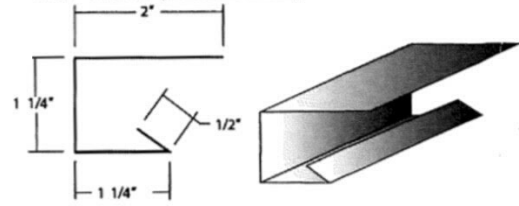

Jamb Trim (PBR-Panel)

Sculptured Rake (PBR-Panel)

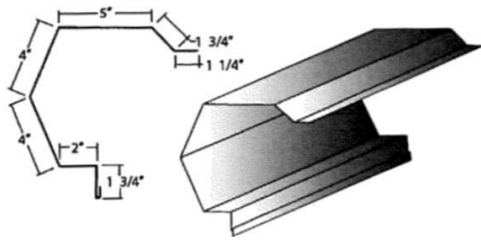

Box Rake (PBR-Panel)

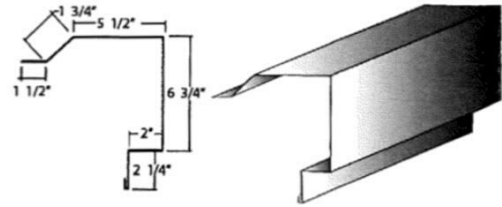

Outside Corner Trim (PBR-Panel)

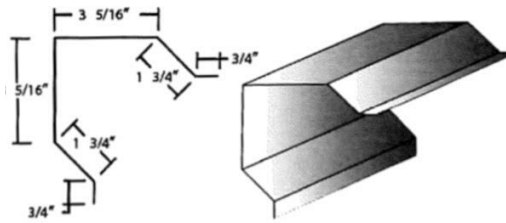

Inside Corner Trim (PBR-Panel)

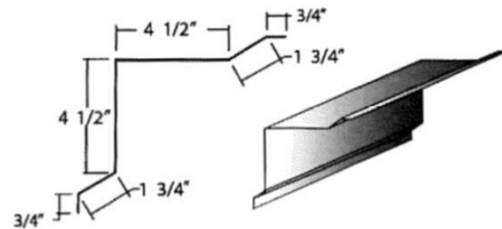

Ridge Flash

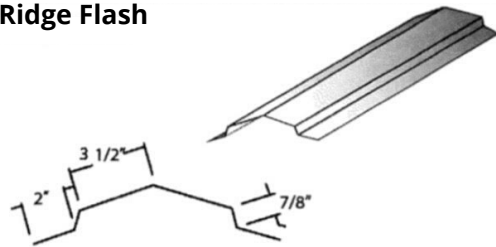

Base Trim

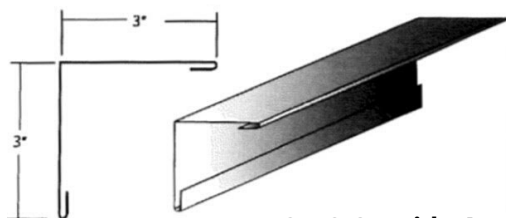
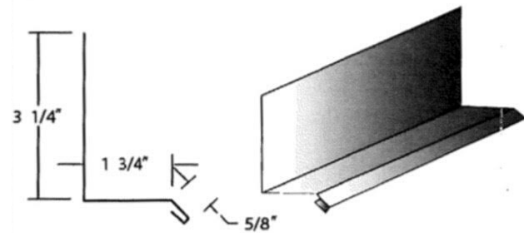

3 x 3 Outside Angle

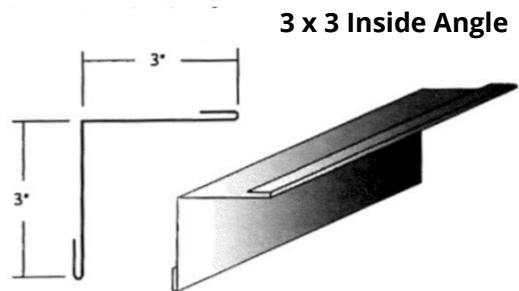

3 x 3 Inside Angle

Sculptured Eave Gutter (PBR-Panel)

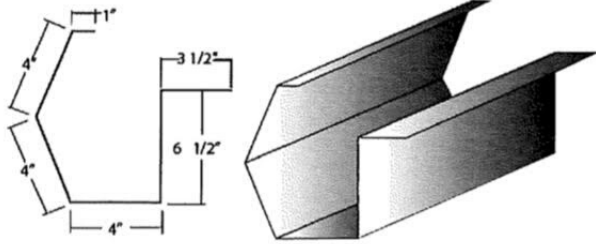

Sculptured Hang-On Gutter (PBR-Panel)

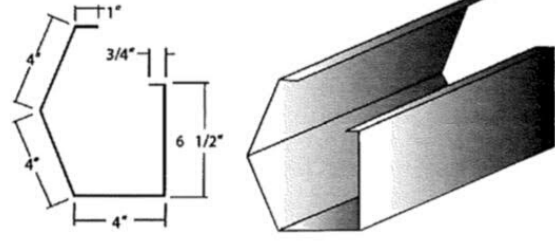

Box Hang-On Gutter

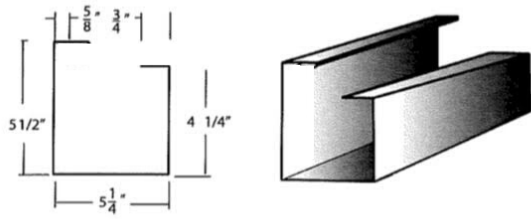

Box Eave Gutter

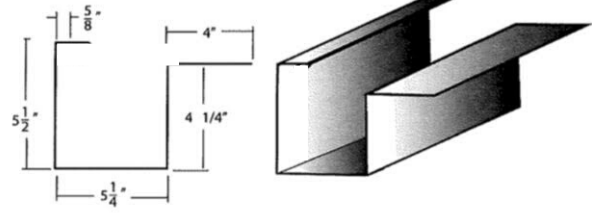

Straight Downspout

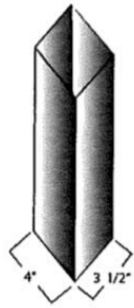

Downspout with 45 Elbow



Downspout Elbow

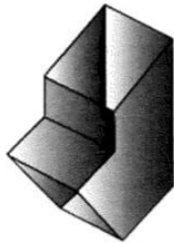

**Gutter Ends
(Left and Right)**

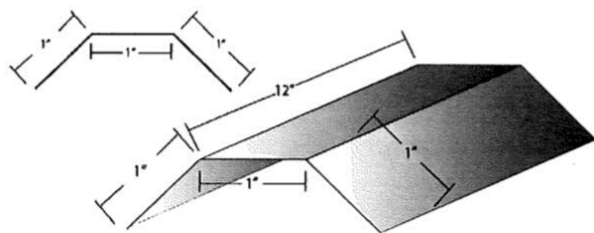
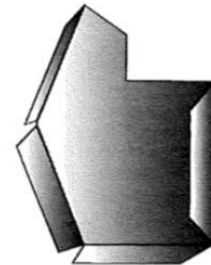

Gutter Strap (PBR-Panel)

Downspout Strap

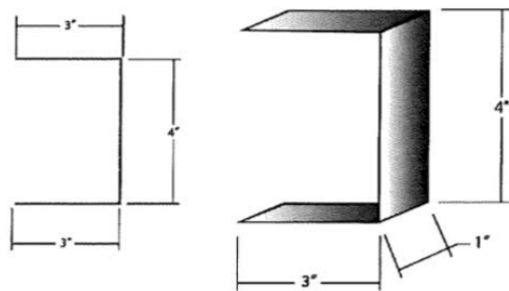

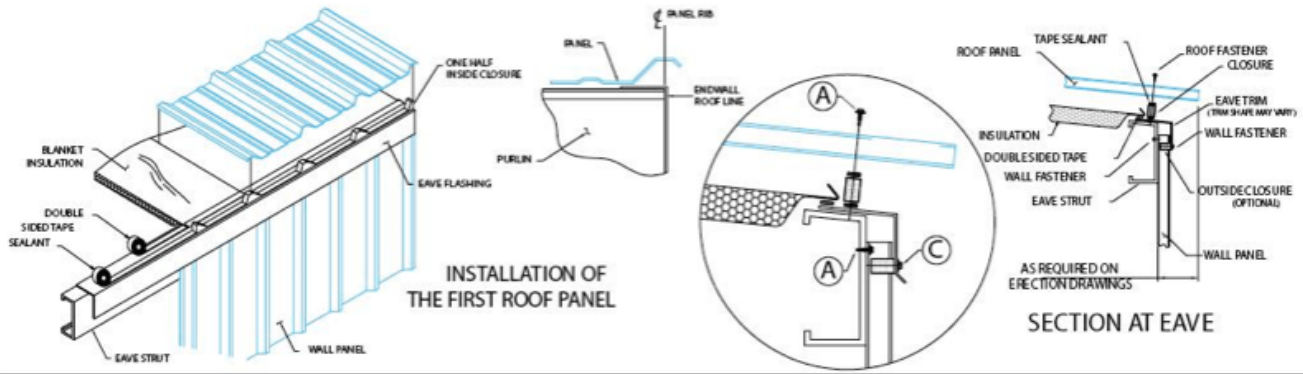

ENDWALL, SIDEWALL & ROOF FASTENER SCHEDULE

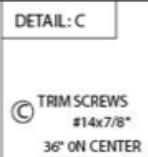
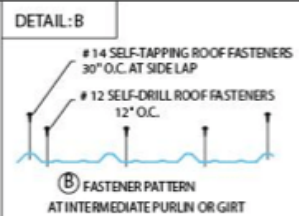
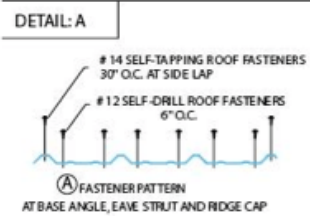
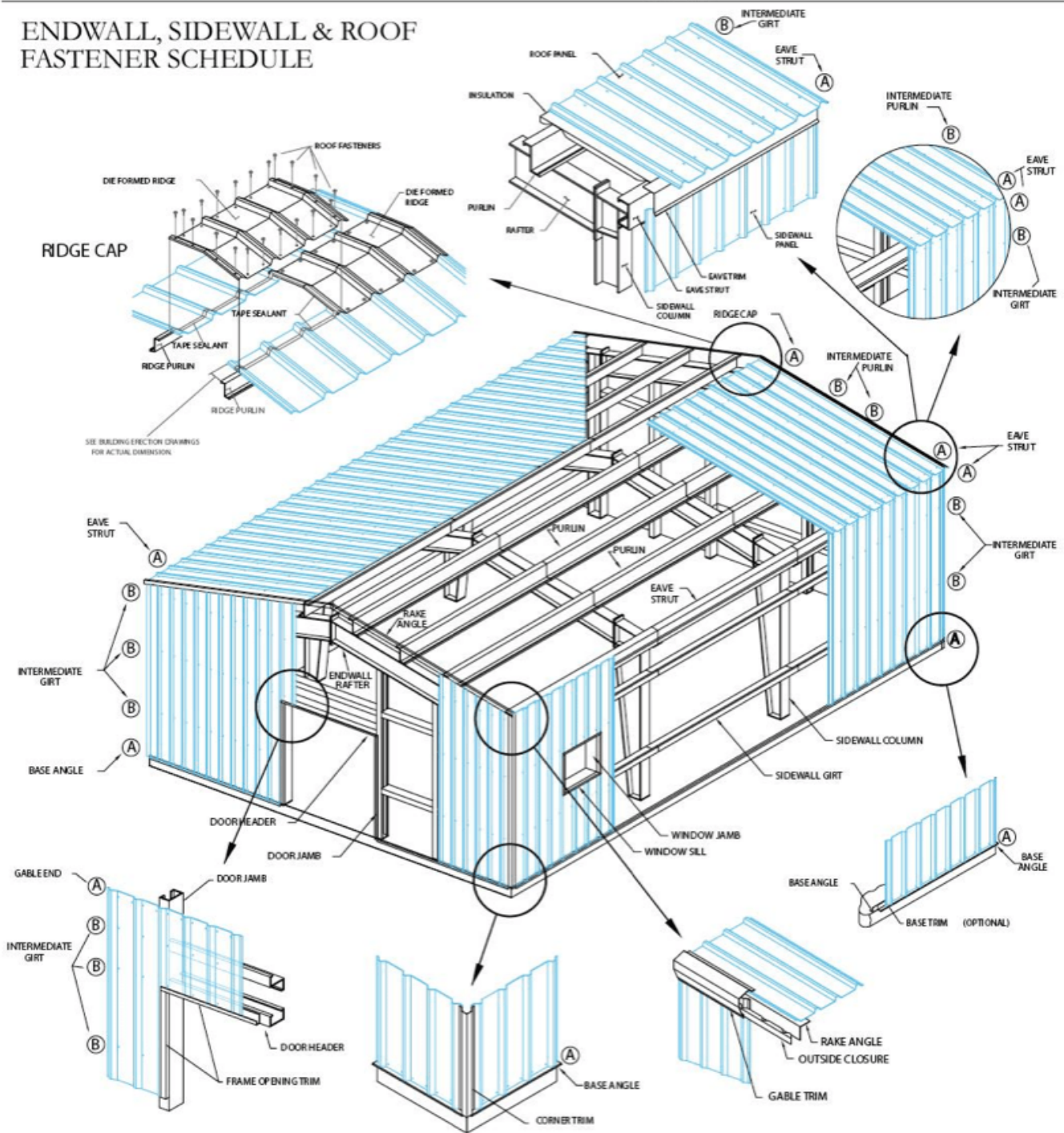



BUNGER STEEL

Gavalume

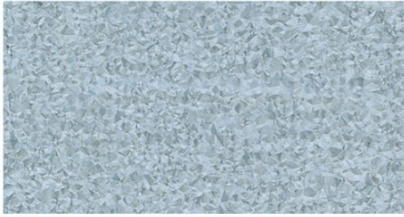

STANDARD COLOR CHART

INQUIRE AS TO THE AVAILABILITY OF OTHER COLORS
*TSR# Is the total solar reflective value for each specific color

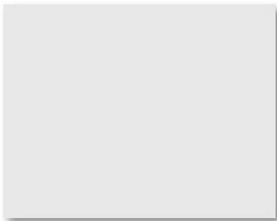

Polar white TSR: 67

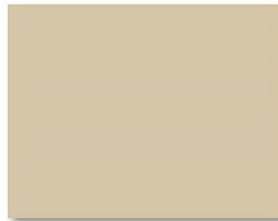

Lightstone TSR: 61



Beige TSR: 46



Tan TSR: 50



Cocoa Brown TSR: 31



Slate TSR: 32



Charcoal TSR: 32



Ash Gray TSR: 50



Rustic Red TSR: 36



Blue TSR: 32



Colony Green TSR: 36



Emerald Green TSR: 30

Color chart is for reference only. Sample chips are available for final color matching.

PREMIUM COLORS



Copper Penny TSR: 46

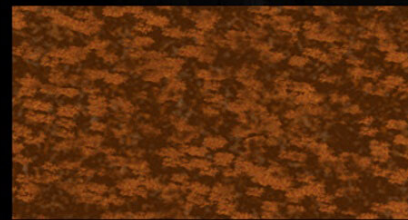

Bunger Rust TSR: 29

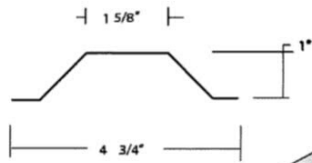

1 " Sub-Girt



Angles

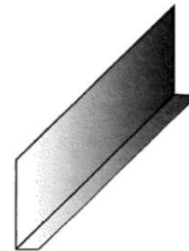

Eave Strut

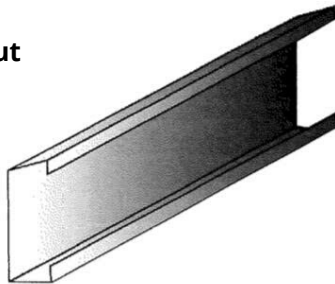

Zee's

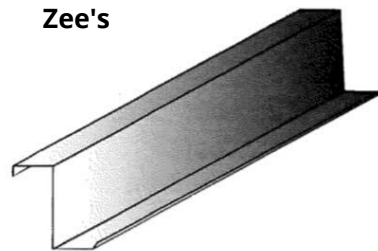

Track

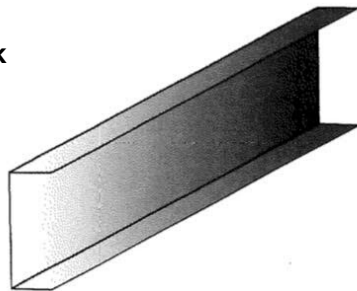

Cee's

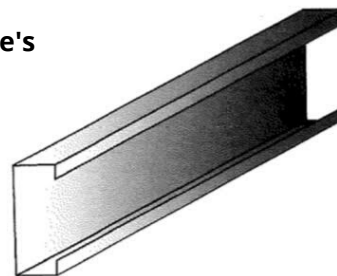

- Available in Galvanized or Red Oxide Primer
- Available in a variety of gauges
- Custom punching available
- Custom bent parts available

VENTS

Bunger Steel provides the accessories you need for air movement and natural light with our quality line of vents and skylights. Each unit is designed for easy weather-tight installation.

RIDGE VENTS

10' sections with or without dampers
Available continuous operations kit

ROUND VENTS

20" diameter round vent

LOW PROFILE RIDGE VENT

Standard color or Galvalume
10' sections
End caps



Continuous Ridge Vent

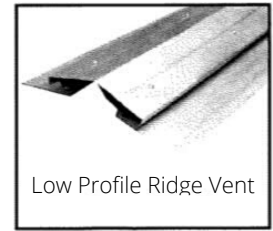

Low Profile Ridge Vent

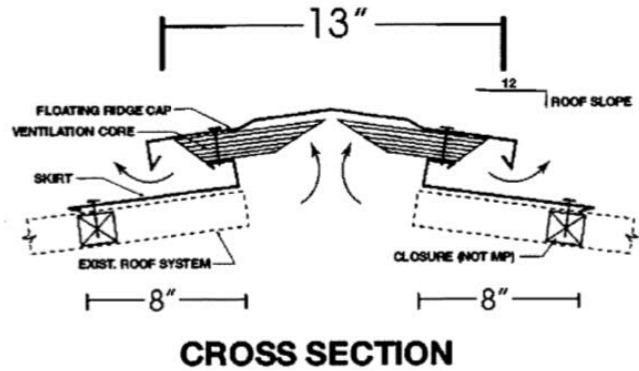

SKYLIGHTS

FIBERGLASS SKYLIGHT

PBR-Panel - 10' 8"
PBM-Panel - 10' 8"

FIBERGLASS-INSULATED SKYLIGHT

White PBR-Panel - 10' 8"

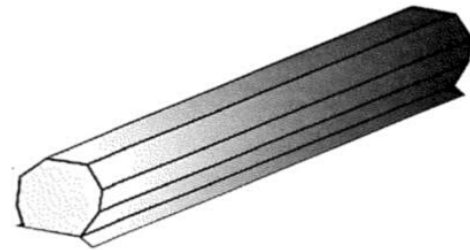

Continuous Ridge Vent with Bird Screen

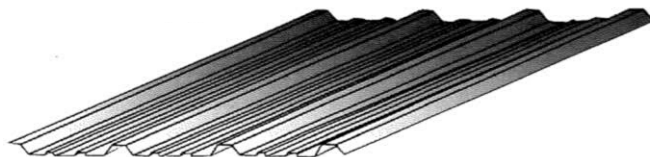

PBR-Panel Skylight

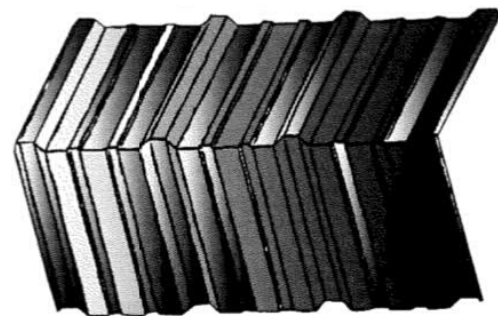

Die Formed Ridge Cap (PBR-Panel)

Please inquire about doors, windows and other accessories.



12 X 3/4" TEK WITH WASHER

These are used for attaching metal to purlins.
(No insulation)

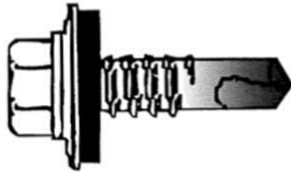

9 X 1" WOOD GRIP

These are used for attaching metal to wood.
(No insulation)



12 X 1-1/4" TEK WITH WASHER

These are used for attaching metal to purlins.
(With 4" insulation)



9 X 1-1/2" WOOD GRIP

These are used for attaching metal to wood.
(With insulation)



14 X 7/8" LAP TEK WITH WASHER

These are used for stitching laps of roofing panels and for attaching trim.

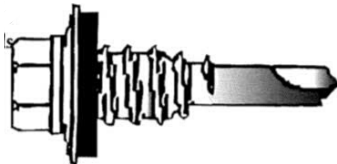

13 X 3/16 POP RIVET



ACCESSORIES

Cable

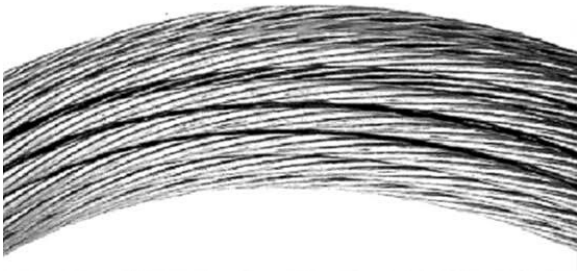

Eye Bolts with nuts



Strand Grip

Rubber Roof Jack



Magnetic Socket

Insulation



Hillside and Flat Washers



Butyl Tape



ALSO AVAILABLE various hot rolled structural shapes.

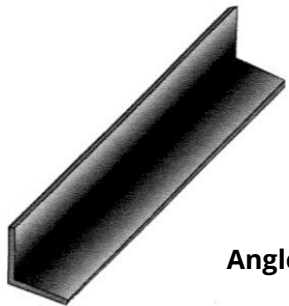

Angle



I Beam

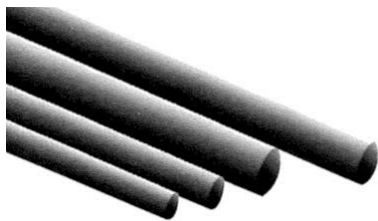

Pipe

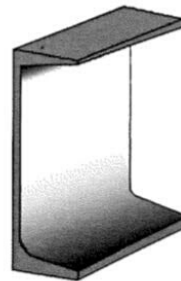

Channel

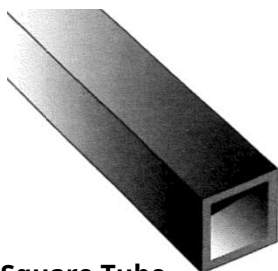

Square Tube

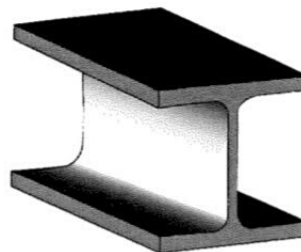

Wide Flange

Please inquire about used pipe and sucker rod.

THE BUNGER DIFFERENCE

STEEL BUILDINGS BETTER BY DESIGN.

CUSTOMIZATION.

Every Bunger Steel building is made to order. We design to your specifications in accordance with your city and county requirements.

EXPREIENCE.

Choosing us means working with a trusted company with decades of experience. 45+ years to be exact. From start to finish, your project is handled by experts.

LOCAL.

We craft every building with passion. Our team listens to your needs and wants to make your dream a reality. Stop by to meet our team!

SINGLE SOURCE.

We are the manufacturer and fabricator for our products. We design, engineer, fabricate, deliver and install your building in house.

BACKED BY US.

Our structures are built to perform year after year. Every building has a 20 year warranty and 35 year paint warranty.

FLEXIBILITY.

We fabricate pre-engineered metal buildings to your custom specifications. Our buildings often include detail that others in the industry add on after fabrication.

COR-TEN®



What is COR-TEN®?

COR-TEN® is the United States Steel Corporation (USS) trade name for an atmospheric corrosion resistant steel. COR-TEN® is a trademarked name owned by U.S. Steel. It refers to a group of steel alloys also known as weathering steel developed in the 1930's by US Steel. It was originally developed for the expanding use of railroad coal wagons.

COR-TEN® is not available. What is available is steel in an A606-4 in metal roofing/siding panels, standing seam panels, flat sheets, and coil form. Designed to have the texture and appearance but without the weakening of rusted steel; COR-TEN® products are commonly favored by end users, architects and general contractors.

How does it work?

The science behind weathering steel is a process by which this specifically designed steel oxidizes as it is exposed to weather like any other type of steel. However, instead of rusting completely through, the top rusted layer creates a barrier and locks in the oxidation to prevent further deterioration of the metal. In a sense, this patina protects the structural integrity of the steel. You can rest assured it is strong and durable while providing a weathered effect to your structure.

What are common uses for COR-TEN®?

We offer COR-TEN® as A606-4 in a number of wall panel types as well as custom trim and flat sheets. A606-4 steel is available in metal roofing/siding panels, standing seam panels, flat sheets, and coil form. Architects often incorporate it into their designs, artists use it for sculptures and contractors use it in landscaping elements as well as roofing and as substitutes for regular steel.



Unlike most steel builders, Bungler Steel is the fabricator, not a broker so you can rest assured the product and service you receive is of superior quality. We continuously develop procedures and policies to ensure a supported and efficient staff. From the solid structural engineering of our buildings to the honesty and reliability of everyone in our organization, integrity is the foundation of every structure and component we build. Our product is produced in a practiced and professional manner from the initial estimate to the final delivery. At Bungler Steel, we hope to inspire innovation in our customers, employees and community. Thank you for your business.

-Brandon Bungler, President



Bunger Steel

8112 W. Buckeye Rd.

Phoenix, AZ 85043

Visit us at bungersteel.com

Open Monday-Friday, 7:30-4:30. Give us a call at 623-936-7181.